

Crucible tongs

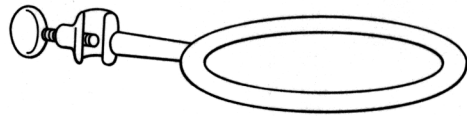

Ring support

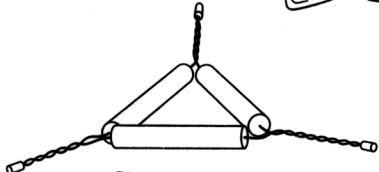

Clay triangle

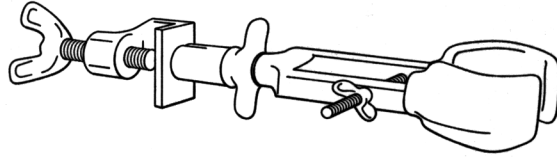

Utility clamp

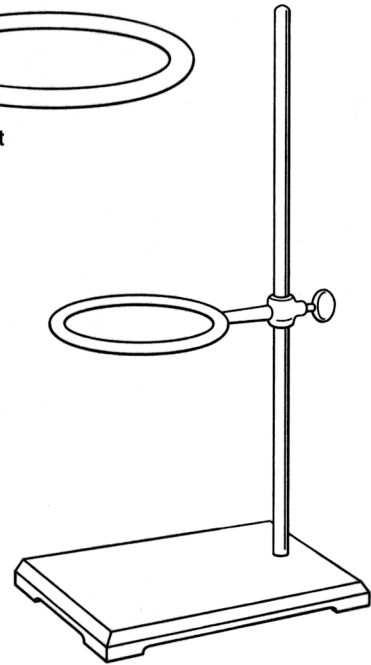

Ring stand



Forceps

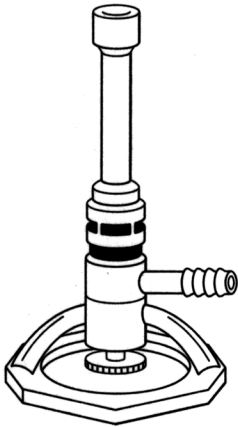

Bunsen burner
(Tirill type)

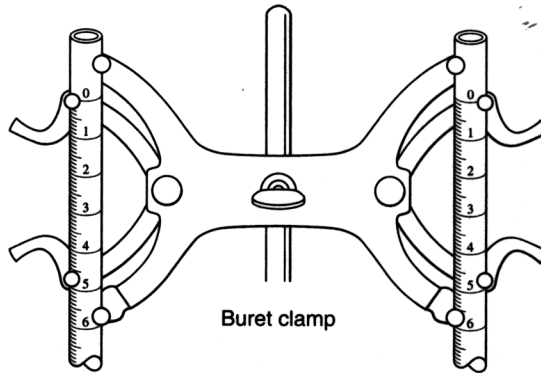

Buret clamp

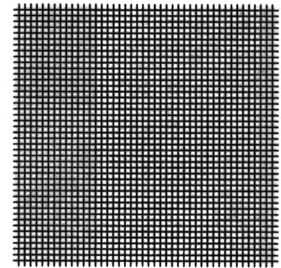

Wire gauze



Test tube holder

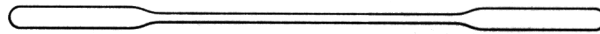

Spatula

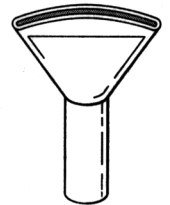

Wing top
(flame spreader)

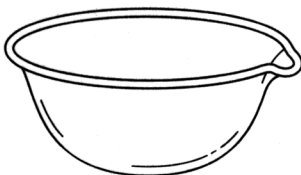

Evaporating dish

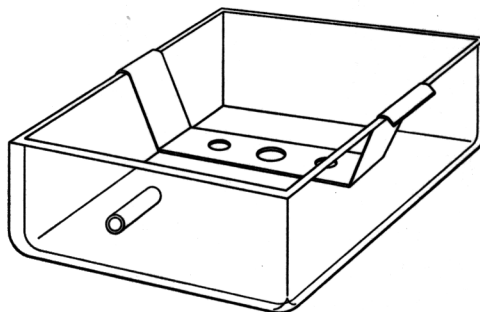

Pneumatic trough



Watch glass

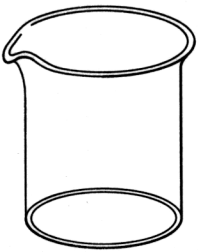

Beaker



Erlenmeyer flask

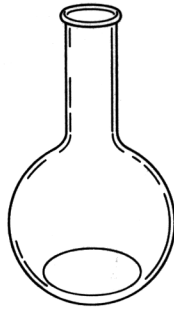

Florence flask

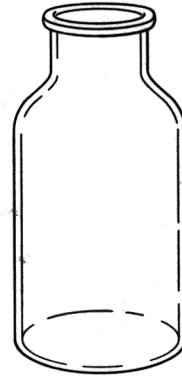

Wide mouth bottle

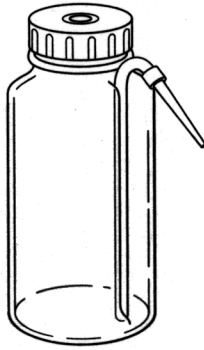

Wash bottle



Test tube brush

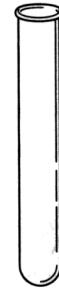

Test tube



Ignition tube



Graduated cylinder



Thermometer

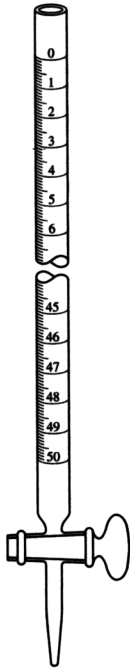

Buret

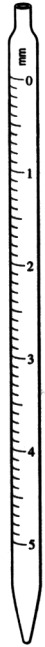

Graduated pipet

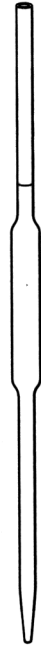

Volumetric pipet

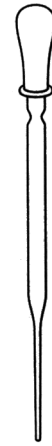

Pasteur pipet



Medicine dropper



Thistle top

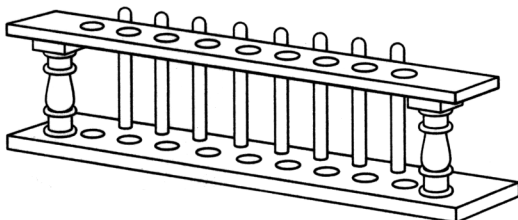

Test tube rack

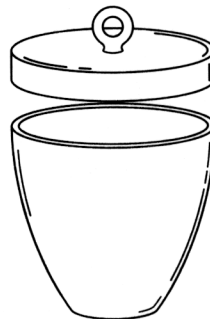

Crucible and cover

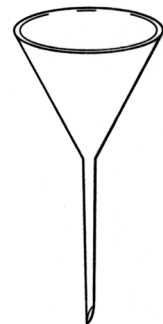

Funnel

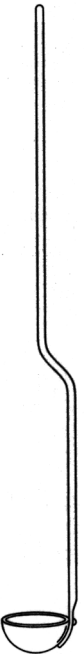

Deflagration spoon